

ASSEMBLY INSTRUCTIONS

FOR

2015 - PRESENT SHELBY MUSTANG*

*For additional vehicle compatibility, visit www.wilwood.com

AEROLITE 4R/MC4 REAR PARKING BRAKE KIT WITH FLEXLINES AND 14.00" DIAMETER VENTED ROTOR

BASE PART NUMBER

Z-140-14002

DISC BRAKES SHOULD ONLY BE INSTALLED BY SOMEONE EXPERIENCED AND COMPETENT IN THE INSTALLATION AND MAINTENANCE OF DISC BRAKES
READ ALL WARNINGS

WARNING

IT IS THE RESPONSIBILITY OF THE PERSON INSTALLING ANY BRAKE COMPONENT OR KIT TO DETERMINE THE SUITABILITY OF THE COMPONENT OR KIT FOR THAT PARTICULAR APPLICATION. IF YOU ARE NOT SURE HOW TO SAFELY USE THIS BRAKE COMPONENT OR KIT, YOU SHOULD NOT INSTALL OR USE IT. DO NOT ASSUME ANYTHING. IMPROPERLY INSTALLED OR MAINTAINED BRAKES ARE DANGEROUS. IF YOU ARE NOT SURE, GET HELP OR RETURN THE PRODUCT. YOU MAY OBTAIN ADDITIONAL INFORMATION AND TECHNICAL SUPPORT BY CALLING WILWOOD AT (805) 388-1188, OR VISIT OUR WEB SITE AT WWW.WILWOOD.COM. USE OF WILWOOD TECHNICAL SUPPORT DOES NOT GUARANTEE PROPER INSTALLATION. **YOU**, OR THE PERSON WHO DOES THE INSTALLATION MUST KNOW HOW TO PROPERLY USE THIS PRODUCT. IT IS NOT POSSIBLE OVER THE PHONE TO UNDERSTAND OR FORESEE ALL THE ISSUES THAT MIGHT ARISE IN YOUR INSTALLATION.

RACING EQUIPMENT AND BRAKES MUST BE MAINTAINED AND SHOULD BE CHECKED REGULARLY FOR FATIGUE, DAMAGE, AND WEAR.



Need Additional Information?
Use Your SmartPhone and
Jump to Our Technical Tips
Section on Our Web Site.



WARNING

DO NOT OPERATE ANY VEHICLE ON UNTESTED BRAKES!
SEE MINIMUM TEST PROCEDURE WITHIN

ALWAYS UTILIZE SAFETY RESTRAINT SYSTEMS AND ALL OTHER AVAILABLE SAFETY EQUIPMENT WHILE OPERATING THE VEHICLE

IMPORTANT • READ THE DISCLAIMER OF WARRANTY INCLUDED IN THE KIT

NOTE: Some cleaners may stain or remove the finish on brake system components. Test the cleaner on a hidden portion of the component before general use.

Important Notice - Read This First

Before any tear-down or disassembly begins, review the following information:

- Review the Wheel Clearance Diagram (Figure 2, page 3) to verify that there is adequate clearance with the wheels you will be using with the installation.
- Due to OEM production differences and other variations from vehicle to vehicle, the fastener hardware and other components in this kit may not be suitable for a specific application or vehicle.
- It is the responsibility of the purchaser and installer of this kit to verify suitability / fitment of all components and ensure all fasteners and hardware achieve complete and proper engagement. Improper or inadequate engagement can lead to component failure.

Photographic Tip

Important and highly recommended: Take photos of brake system before disassembly and during the disassembly process. In the event, trouble-shooting photos can be life savers. Many vehicles have undocumented variations, photos will make it much simpler for Wilwood to assist you if you have a problem.

Exploded Assembly Diagram

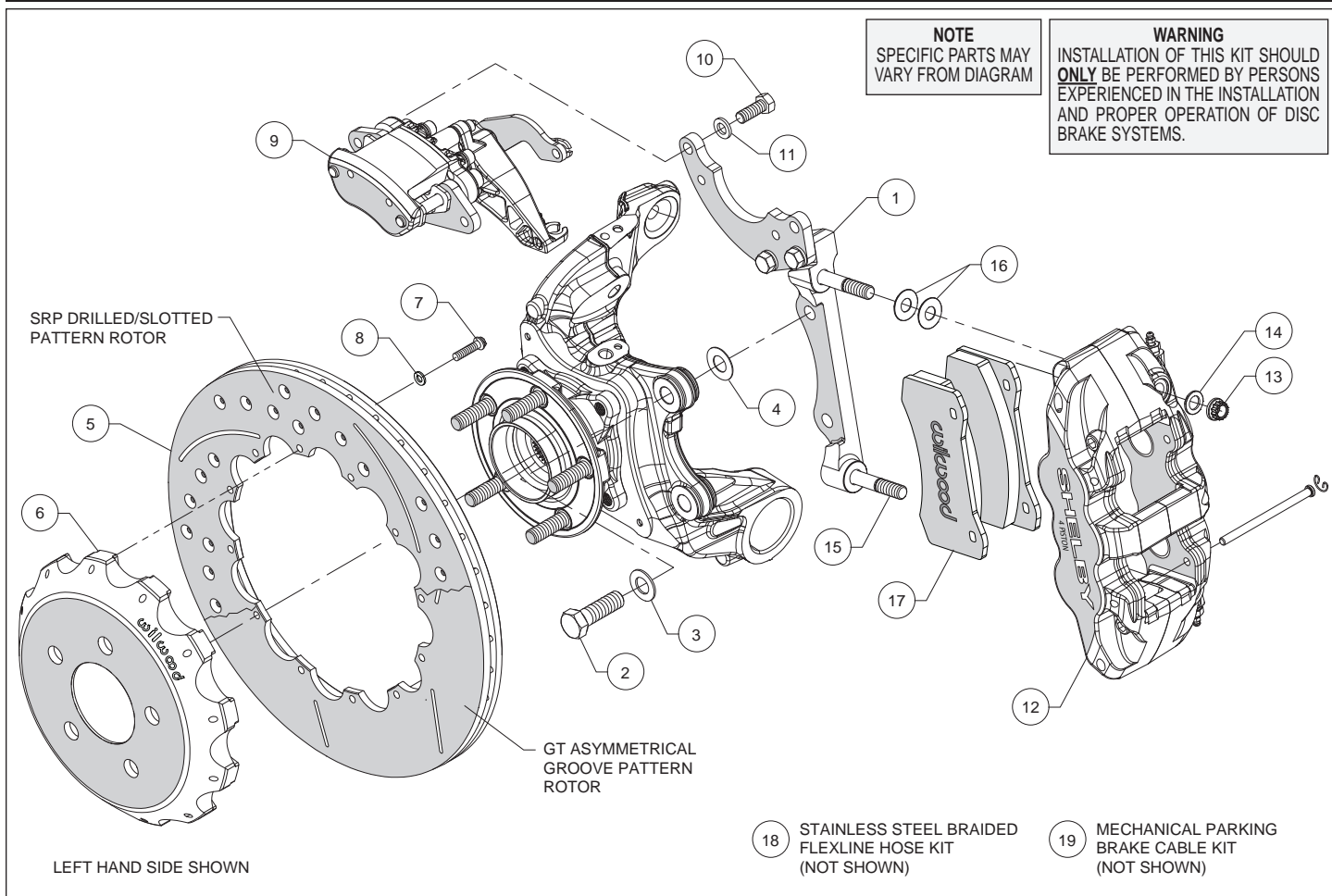

Figure 1. Typical Installation Configuration

Parts List

ITEM NO.	PART NO.	DESCRIPTION	QTY
1	249-14009/10	Bracket, Caliper Mounting	1
2	230-13152	Bolt, M14-2.00 x 45mm, Hex Head	4
3	240-11855	Washer, .578 I.D. x 1.062 O.D. x .063 Thick	4
4	240-8969	Shim, .029 Thick	16
5	160-12885/86-BK	Rotor, .81" x 14.00" Dia, 12 x 8.75" Bolt Circle (one each, right and left)	2
6	170-13927	Hat, 5 x 4.50, 1.200 Offset, 12 x 8.75" Bolt Circle	2
7	230-6737	Bolt, 1/4-20 x 1.00 Long, 12 Point	24
8	240-11240	Washer, .265 I.D. x .500 O.D. x .063 Thick	24
9	120-14007/08-BK	Caliper, MC4 Parking Brake, Black	2
9A	120-14007/08-RD	Caliper, MC4 Parking Brake, Red	2
10	230-10024	Bolt, 3/8-24 x 1.00 Long, Hex Head	4
11	240-10190	Washer, .391 I.D. x .625 O.D. x .063 Thick	4
12	Z-120-14003-BK	Caliper, Aerolite 4R, Black	2
12A	Z-120-14003-RD	Caliper, Aerolite 4R, Red	2
13	230-9182	Nut, 7/16-20, Self-Locking, 12 Point	4
14	240-11101	Washer, .453 I.D. x .750 O.D. x .063 Thick	4
15	230-13776	Stud, 7/16-14 x 7/16-20 x 2.875 long (pre installed in bracket)	4
16	240-1848	Shim, .030 Thick	12
17	150-9188K	Pad, BP-10 Compound, Axle Set	1
18	220-13913	Stainless Steel Braided Flexline Hose Kit (not shown)	1
19	330-15137	Cable Kit, Mechanical Parking Brake (not shown)	1

NOTES: Part Number 230-12078 Caliper Bolt Kit, includes part numbers 230-10024 and 240-10190
 Part Number 230-4572 Rotor Bolt Kit, includes part numbers 230-6737 and 240-11240
 Part Number 230-13684 Spindle/Bracket Mounting Bolt Kit, includes part numbers 230-13152, 240-8969 and 240-11855
 Part Number 249-14009/10 Caliper Bracket Kit, includes P/N's 230-9182, 230-13776, 240-1848, 240-11101, 250-14009 and 250-14010
 Items 9A and 12A are optional items and included with the "-R" red caliper kits. Add "-R" to end of part number when ordering.

General Information and Disassembly Instructions

- Installation of this kit should **ONLY** be performed by persons experienced in the installation and proper operation of disc brake systems. Before assembling this Wilwood rear disc brake kit, double check the following to ensure a trouble free installation.
- Inspect the contents of this kit against the parts list to ensure that all components and hardware are included.
- Make sure this is the correct kit to fit the exact make and model year of your vehicle. This kit is designed for direct bolt-on installation to 2015-Present model year Shelby Mustang axle hubs.
- Verify your wheel clearance using Figure 2.
- Verify that the factory axle hub center register diameter and lug pattern match those in the new hat. **NOTE:** Axle hubs that have been modified with different size studs or lug patterns may require modifications to the new hat that must be performed by a qualified machinist.

Disassembly

- Disassemble the original equipment front brakes:
 - Raise the rear wheels off the ground and support the rear suspension according to the vehicle manufacturer's instructions.
 - Remove the rear wheels, calipers, and rotors.
- Remove any nicks or burrs on the axle hub and upright that may interfere with the installation of the new brake components.
- Clean and de-grease the axle hub and upright assembly.

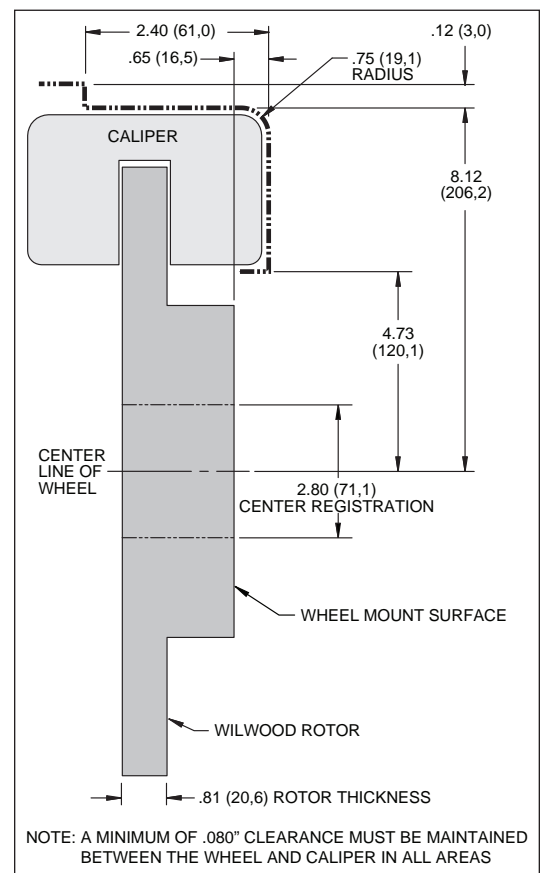

Figure 2. Wheel Clearance Diagram

Assembly Instructions

Assembly Instructions (numbers in parenthesis refer to the parts list and Figure 1 on the preceding pages):

- The caliper mount bracket (1) should initially be installed with clean, dry threads on the mounting bolts. Orient the bracket as shown in Figure 1, and Photo 1, and install using bolts (2) and washers (3). Initially place one .029" thick shim (4) on each bolt between the bracket and upright, Figure 1. Temporarily tighten the mounting bolts. **NOTE:** *The bracket must fit squarely against the mount bosses on the upright.* Inspect for interference from casting irregularities, machining ridges, burrs, etc. Later, after the caliper alignment has been checked, the mount bolts will be secured using red *Loctite*[®] 271.



Photo 1
(Left side shown)



Photo 2

- Orient the rotor (5) and the hat (6) as shown in Figure 1 and Photo 2. Attach rotor to hat using bolts (7) and washers (8). Using an alternating sequence, apply red *Loctite*[®] 271 to the threads, and torque to 155 **in-lbs**. For an added measure of security, the bolts may be safety wired using standard 0.032 inch diameter stainless steel safety wire as shown in Figure 3. Please refer to Wilwood's data sheet DS-386 (available at www.wilwood.com/Pdf/DataSheets/ds386.pdf) for complete safety wire installation instructions.

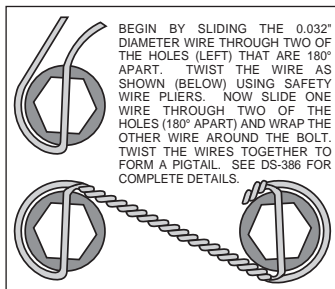

Figure 3. Safety Wire Diagram



Photo 3

- Slide the hat/rotor assembly onto the axle hub. **NOTE:** *The hat must fit flush against the axle hub flange or excessive rotor run out may result.* Install three lug nuts (finger tight) to keep the hat/rotor assembly in place while continuing with the installation, Photo 3.

- Lubricate the caliper mounting studs (15) with lightweight oil. Initially place two .030" thick shims (16) on each stud as shown in Figure 1 and Photo 4. Mount the caliper (12) onto the bracket (1) using lock nuts (13) and washers (14), Figure 1. Temporarily tighten the lock nuts and view the rotor through the top opening of the caliper. The rotor should be centered in the caliper, Photo 5. If not, adjust by adding or subtracting shims (4) between the bracket and the mounting bosses. Always use the same amount of shims on each of the two mounting bolts. Once the caliper alignment is correct, remove the bracket mounting bolts one at a time, apply red *Loctite*[®] 271 to the threads, and torque to 77 ft-lb.

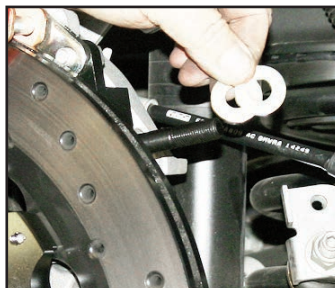

Photo 4

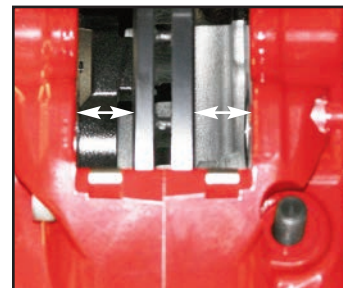

Photo 5

- Remove the two pad retaining pins from the caliper (12) by carefully popping out the pin retaining clips and sliding out the pins. Insert the brake pads (17) into the caliper from the bottom, Figure 1 and Photo 6. With the friction material facing the rotor, secure the brake pads in place with the pad retaining pins and clips, Photo 7. Reinstall the caliper onto the caliper mounting bracket and temporarily tighten the lock nuts. Check that the top of the brake pad is flush with the outside diameter of the rotor, Photo 8. If not, adjust by adding or subtracting shims (16) between the caliper and the bracket. After the caliper pad height is set, torque the caliper lock nuts (13) to 47 ft-lb.



Photo 6



Photo 7

- Orient the parking brake caliper (9), as shown in Figure 1 and Photo 9, and mount onto the top section of the caliper mounting bracket (1) using bolts (10) and washers (11), Figure 1. **NOTE:** *For this kit, the parking brake caliper marked 'right hand'*

Assembly Instructions (Continued)

MUST be mounted on the left side of the car, and vice versa. Apply red Loctite® 271 to bolt threads, and torque to 30 ft-lb.

- Temporarily install the wheel and torque the lug nuts to the manufacturer's specification. Ensure that the wheel rotates freely without any interference.

• **NOTE:** OEM rubber brake hoses generally cannot be adapted to Wilwood calipers. The caliper inlet fitting is a 1/8-27 NPT. Install Wilwood's stainless steel braided flexline hose kit (18), P/N 220-13913 included with this kit as shown in Photo 10. **Carefully route hoses to prevent contact with moving suspension, brake or wheel components.** **NOTE:** Wilwood hose kits are designed for use in many different vehicle applications and it is the installer's responsibility to properly route and ensure adequate clearance and retention for brake hose components.

- Install new flexline bracket, as shown in Photo 10, using OEM bracket bolt.

- Retain hose with new cable clamp, as shown in Photo 10, using OEM bolt.

• **NOTE:** Specified brake hose kits may not work with all Years, Makes and Models of vehicle that this brake kit is applicable to, due to possible OEM manufacturing changes during a production vehicle's life. It is the installer's responsibility to ensure that all fittings and hoses are the correct size and length, to ensure proper sealing and that they will not be subject to crimping, strain and abrasion from vibration or interference with suspension components, brake rotor or wheel.

• In absence of specific instructions for brake line routing, the installer must use his best professional judgment on correct routing and retention of lines to ensure safe operation. Test vehicle brake system per the 'minimum test' procedure stated within this document before driving. After road testing, inspect for leaks and interference. Initially after install and testing, perform frequent checks of the vehicle brake system and lines before driving, to confirm that there is no undue wear or interference not apparent from the initial test. Afterwards, perform periodic inspections for function, leaks and wear in a interval relative to the usage of vehicle.

- Bleed the brake system, referring to the additional information and recommendations on page 8 for proper bleeding instructions. Check system for leaks after bleeding.

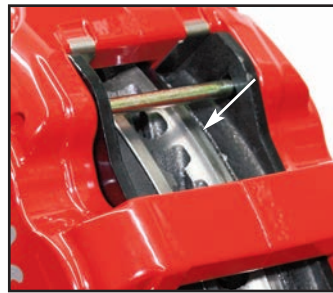

Photo 8



Photo 9
(Left side shown)

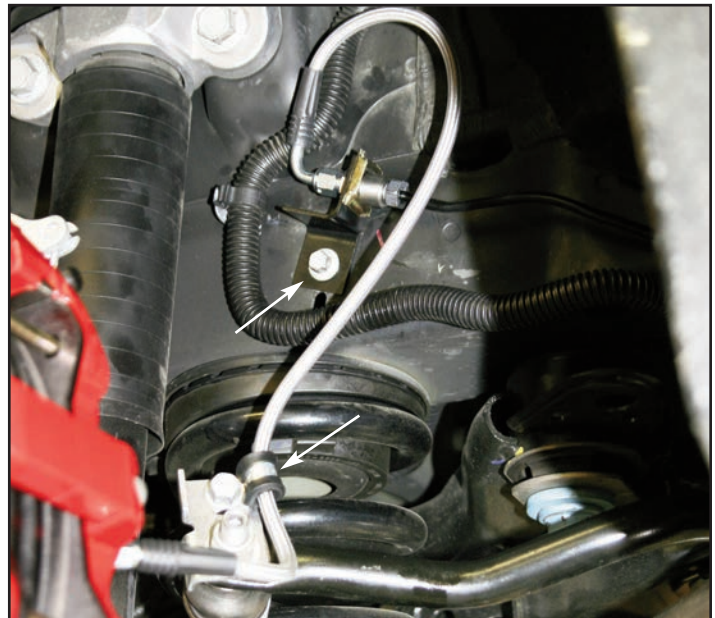

Photo 10 (Left side shown)

IMPORTANT:

- To ensure maximum performance from your parking brake system, the cables must be routed as straight as possible. Bends in the cable can significantly reduce efficiency and thus reduce pull force at the brake. Tight bends must be avoided with a minimum recommended bend radius of 6" to 8".
- Cables should be properly restrained to prevent "straightening" of bends when tension is applied. Restrain movement of cable by affixing the cable sheath to body or chassis by fitting cable clamps at various points over the length of cable or by using original equipment cable attachments points. The clamping method chosen will require that cable sheath be held tightly without movement, crushing or causing interference to the internal cable.
- Cables must be initially pre-stretched by multiple applications of the brake handle, then re-adjusted to correct tension.

Assembly Instructions (Continued)

- Install new parking brake cable kit, P/N 330-15137 (included in this kit), as follows: **NOTE:** *Original equipment cable will not adapt to Wilwood calipers.*

- **NOTE:** *The new driver and passenger side cables differ in length and must be installed on the correct side of the vehicle. The driver's side cable is shorter.*

FROM INSIDE THE VEHICLE:

- Be sure parking brake lever is released (off) inside the vehicle.

FROM UNDERNEATH THE VEHICLE:

- **NOTE:** *Make note of the existing cable routing along the chassis. The Wilwood cables will be installed along the same path in that area.*

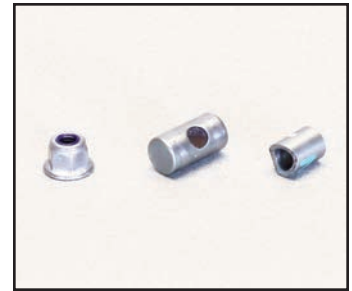

Photo 11

- Detach OEM cables from the OEM rear calipers.
- At the balance bar, detach the OEM cables from the bulkhead (in the driveshaft tunnel). Install a small hose clamp so that it surrounds the spring clip at the bulkhead. Using a long screwdriver, tighten the hose clamp around the spring clip and pull on the cable from the rear until it comes free of the bulkhead, and remove. Perform the same technique on the second cable and remove.
- Remove both left and right side cables, and balance bar. Save the nut, barrel, and sleeve that will be reused with the Wilwood cable kit, Photo 11.

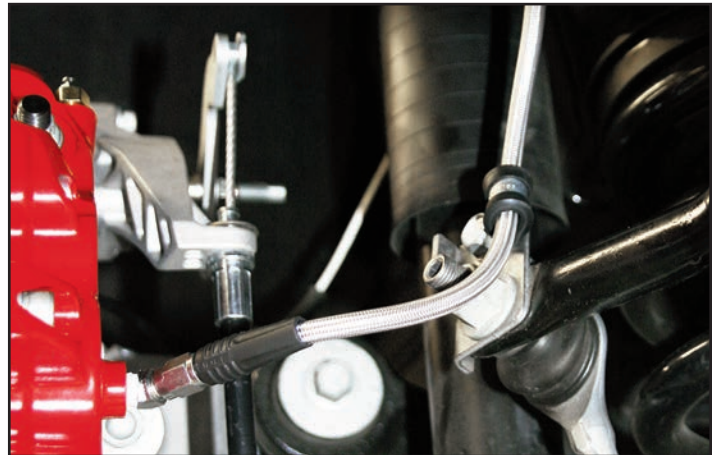

Photo 12 (Left side shown)

- Remove and save the brackets holding the OEM cable to the chassis. They will be reused on the new cable.
- Install the OEM brackets over the Wilwood cables in the same position that they were removed from the original cables.
- Attach E-clip end of the new cable to the caliper, Photo 12. Ensure that the E-clip is fully engaged into its groove.
- Route the new cable from the caliper to the chassis as shown in Photos 12, 13, and 14. **Carefully route cable to prevent contact with exhaust or moving suspension, brake or wheel components.** **NOTE:** *it's the installer's responsibility to properly route and ensure adequate clearance and retention for parking brake cable components.*



Photo 13 (Left side shown)

- Complete the routing of the cable along the chassis, to the balance bar, in the same location as the OEM cable.
- Attach the other end of the new cable to the new balance bar as shown in Photo 15. Reuse the OEM nut, barrel, and sleeve.
- Retain new cable with new cable clamp and self tapping screw, as shown in Photo 13. Drill pilot hole using a #3 drill bit (.203 diameter) in approximate location shown.
- Repeat the above steps for the other side cable.
- Attach OEM brackets, that were installed over the new cable, in their original mounting holes.
- Tighten all bracket bolts and hardware.

Assembly Instructions (Continued)

- Adjust parking brake:

1. With the parking brake off, loosen adjustment bolt jam nut (on the parking brake caliper).
2. Tighten the adjustment bolt until there is some drag on the rotor.
3. Repeat steps 1 and 2 for other rear wheel caliper.
4. Back off adjustment bolt one-half turn on each caliper.
5. Ensure there is no rotation of adjustment bolt and tighten jam nut 80-120 **in-lb.** on each caliper.
6. Check for drag on each rotor. A slight rubbing sound during rotation is acceptable.

- Install the wheel and torque the lug nuts to the manufacturer's specification.

- Bed-in your brake pads per the procedure on page 9.

- After bleeding and bedding the brakes per these installation instructions, carefully test the holding power of the parking brakes. Test parking brake in a safe area, first on a flat surface by pushing on the vehicle, then on a slight incline by applying and releasing handle multiple times. Refer to instructions on the last page.

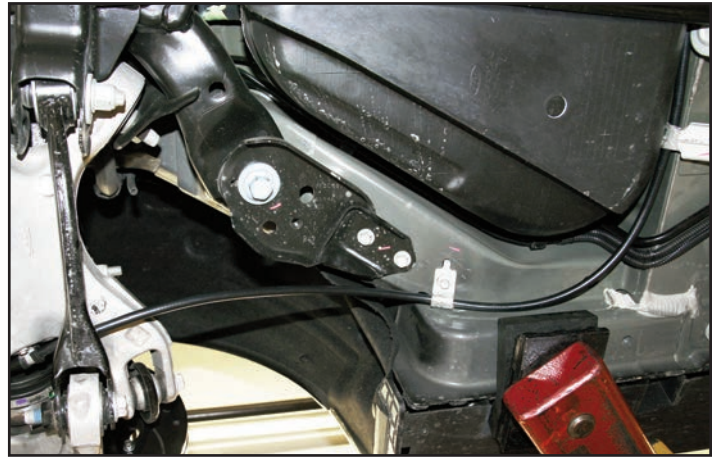

Photo 14 (Left side shown)



Photo 15

Additional Information and Recommendations

• Fill and bleed the new system with Wilwood Hi-Temp[®] 570 grade fluid or higher. For severe braking or sustained high heat operation, use Wilwood EXP 600 Plus Racing Brake Fluid. Used fluid must be completely flushed from the system to prevent contamination.
NOTE: Silicone DOT 5 brake fluid is **NOT** recommended for racing or performance driving.

• To properly bleed the brake system, begin with the caliper farthest from the master cylinder. Bleed the outboard bleed screw first, then the inboard. Repeat the procedure until all calipers in the system are bled, ending with the caliper closest to the master cylinder.
NOTE: When using a new master cylinder, it is important to bench bleed the master cylinder first.

• Test the brake pedal. It should be firm, not spongy and stop at least 1 inch from the floor under heavy load.

If the brake pedal is spongy, bleed the system again.

If the brake pedal is initially firm, but then sinks to the floor, check the system for fluid leaks. Correct the leaks (if applicable) and then bleed the system again.

If the brake pedal goes to the floor and continued bleeding of the system does not correct the problem, a master cylinder with increased capacity (larger bore diameter) may be required. Wilwood offers various lightweight master cylinders with large fluid displacement capacities.

• **NOTE:** With the installation of after market disc brakes, the wheel track may change depending on the application. Check your wheel offset before final assembly.

• If after following the instructions, you still have difficulty in assembling or bleeding your Wilwood disc brakes, consult your local chassis builder, or retailer where the kit was purchased for further assistance. Additional information is also available on our web site at www.wilwood.com, or e-mail: info@wilwood.com.

Brake Testing

WARNING • DO NOT DRIVE ON UNTESTED BRAKES BRAKES MUST BE TESTED AFTER INSTALLATION OR MAINTENANCE MINIMUM TEST PROCEDURE

- Make sure pedal is firm: Hold firm pressure on pedal for several minutes, it should remain in position without sinking. If pedal sinks toward floor, check system for fluid leaks. DO NOT drive vehicle if pedal does not stay firm or can be pushed to the floor with normal pressure.
- At very low speed (2-5 mph) apply brakes hard several times while turning steering from full left to full right, repeat several times. Remove the wheels and check that components are not touching, rubbing, or leaking.
- Carefully examine all brake components, brake lines, and fittings for leaks and interference.
- Make sure there is no interference with wheels or suspension components.
- Drive vehicle at low speed (15-20 mph) making moderate and hard stops. Brakes should feel normal and positive. Again check for leaks and interference.
- Always test vehicle in a safe place where there is no danger to (or from) other people or vehicles.
- Always wear seat belts and make use of all safety equipment.

Pad and Rotor Bedding

BEDDING STEPS FOR NEW PADS AND ROTORS – ALL COMPOUNDS

Once the brake system has been tested and determined safe to operate the vehicle, follow these steps for the bedding of all new pad materials and rotors. These procedures should only be performed on a race track, or other safe location where you can safely and legally obtain speeds up to 65 MPH, while also being able to rapidly decelerate.

- Begin with a series of light decelerations to gradually build some heat in the brakes. Use an on-and-off the pedal technique by applying the brakes for 3-5 seconds, and then allow them to fully release for a period roughly twice as long as the deceleration cycle. If you use a 5 count during the deceleration interval, use a 10 count during the release to allow the heat to sink into the pads and rotors.
- After several cycles of light stops to begin warming the brakes, proceed with a series of medium to firm deceleration stops to continue raising the temperature level in the brakes.
- Finish the bedding cycle with a series of 8-10 hard decelerations from 55-65 MPH down to 25 MPH while allowing a proportionate release and heat-sinking interval between each stop. The pads should now be providing positive and consistent response.
- If any amount of brake fade is observed during the bed-in cycle, immediately begin the cool down cycle.
- Drive at a moderate cruising speed, with the least amount of brake contact possible, until most of the heat has dissipated from the brakes. Avoid sitting stopped with the brake pedal depressed to hold the car in place during this time. Park the vehicle and allow the brakes to cool to ambient air temperature.

COMPETITION VEHICLES

- If your race car is equipped with brake cooling ducts, blocking them will allow the pads and rotors to warm up quicker and speed up the bedding process.
- Temperature indicating paint on the rotor and pad edges can provide valuable data regarding observed temperatures during the bedding process and subsequent on-track sessions. This information can be highly beneficial when evaluating pad compounds and cooling efficiencies.

POST-BEDDING INSPECTION – ALL VEHICLES

- After the bedding cycle, the rotors should exhibit a uniformly burnished finish across the entire contact face. Any surface irregularities that appear as smearing or splotching on the rotor faces can be an indication that the brakes were brought up to temperature too quickly during the bedding cycle. If the smear doesn't blend away after the next run-in cycle, or if chatter under braking results, sanding or resurfacing the rotors will be required to restore a uniform surface for pad contact.

PRE-RACE WARM UP

- Always make every effort to get heat into the brakes prior to each event. Use an on-and-off the pedal practice to warm the brakes during the trip to the staging zone, during parade laps before the flag drops, and every other opportunity in an effort to build heat in the pads and rotors. This will help to ensure best consistency, performance, and durability from your brakes.

DYNO BEDDED COMPETITION PADS AND ROTORS

- Getting track time for a proper pad and rotor bedding session can be difficult. Wilwood offers factory dyno-bedded pads and rotors on many of our popular competition pads and **Spec 37** GT series rotors. Dyno-bedded parts are ready to race on their first warm up cycle. This can save valuable time and effort when on-track time is either too valuable or not available at all, Dyno-bedding assures that your pads and rotors have been properly run-in and are ready to go. Contact your dealer or the factory for more information on Wilwood Dyno-Bedding services.

NOTE:

NEVER allow the contact surfaces of the pads or rotors to be contaminated with brake fluid. Always use a catch bottle with a hose to prevent fluid spill during all brake bleeding procedures.

Parking Brake

WARNING • PARKING BRAKE

- Parking brake must be properly adjusted before use and must be manually readjusted for wear if parking brake handle or foot lever travel becomes excessive.
- The holding ability of the brake should be tested by stopping on a sloping surface and applying the parking brake while holding car with the hydraulic foot brake. This should be accomplished both facing up and down hill.
- Do not rely exclusively on the parking brake to hold the car; Curb wheels as recommended by the applicable diagram and put gear selector in park, or shift into first gear or reverse with a manual transmission.

- Diagram A - When parking facing downhill, turn front wheels towards the curb or right shoulder. This will keep from rolling into traffic if the brakes become disengaged.
- Diagram B - Turn the steering wheel to the left so the wheels are turned towards the road if you are facing uphill with a curb. The tires will catch the curb if the car rolls backward.
- Diagram C - When facing uphill without a curb, turn the wheels sharply to the right. If the vehicle rolls, it will go off the road rather than into traffic.
- When parking on a hill, always set the parking brake and move the gear selector into park, or shift into first or reverse gear if your vehicle has a manual transmission.

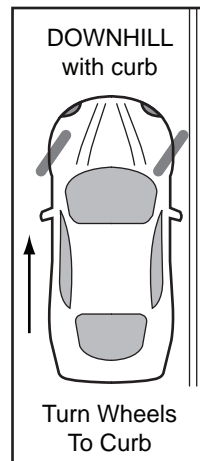

Diagram A

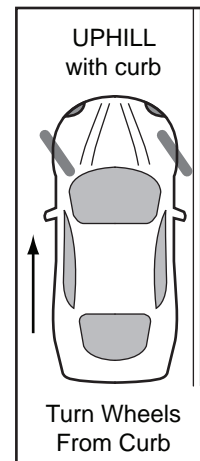

Diagram B

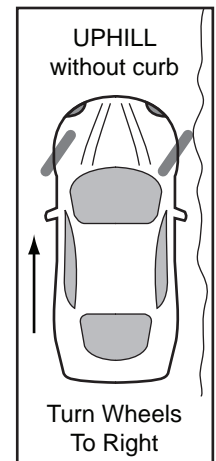

Diagram C

Connect with Wilwood

Wilwood Facebook



Wilwood Twitter



Wilwood YouTube



Associated Components

<u>PART NO.</u>	<u>DESCRIPTION</u>
260-8555	Wilwood 1.00" Bore Aluminum Tandem Master Cylinder
260-8556	Wilwood 1.12" Bore Aluminum Tandem Master Cylinder
260-13706	Wilwood Residual Pressure Valve (2 lb for disc brakes)
260-13707	Wilwood Residual Pressure Valve (10 lb for drum brakes)
260-8419	Wilwood Proportioning Valve
260-11179	Wilwood Combination Proportioning Valve with Brake Light Switch
290-0632	Wilwood Racing Brake Fluid (Hi-Temp° 570) (12 oz)
290-6209	Wilwood Racing Brake Fluid (EXP 600 Plus) (16.9 oz)
290-11084	Wilwood "FIVE" DOT 5 Silicone Brake Fluid (12 oz) • NOT Recommended for Racing
290-11087	Wilwood Synthetic Assembly Lube (4 oz)
150-9489K	BP-20 Street Performance / Racing Brake Pads • Baseline Pad for Track Oriented Street Cars
150-12251K	BP-40 High Temperature Racing Brake Pads • Race Only Pad for Severe Duty Oval, Road Course, or Off-Road
220-7056	Stainless Steel Braided Flexline Kit, Universal, 14 Inch, Domestic, 3/8-24 IF
220-7699	Stainless Steel Braided Flexline Kit, Universal, 16 Inch, Domestic, 3/8-24 IF
220-8307	Stainless Steel Braided Flexline Kit, Universal, 18 Inch, Domestic, 3/8-24 IF
220-8338	Stainless Steel Braided Flexline Kit, Universal, 14 Inch, Metric 10mm x 1.0
220-6856	Stainless Steel Braided Flexline Kit, Universal, 18 Inch, Metric 10mm x 1.0
220-13684	Stainless Steel Braided Flexline Kit, 2015-Present Ford Mustang, Rear
330-15137	Parking Brake Cable Kit, 2015-Present Shelby Mustang (Included in this kit)