

Master Cylinder Reservoir Caps with Electronic Fluid Level Sensors

Fluid Cap Highlights:

- Checks fluid level electronically and indicates when fluid level needs attention.
- Utilizes standard automotive 12V DC male terminals for long service life and easy installation of the electrical circuit.
- The cap is manufactured from durable lightweight Nylon which has a high melting point and superior color fastness, perfect for engine compartment environments.
- The internal float is made from a proprietary material, offering excellent dimensional stability to yield accurate readings.
- Cap diaphragm provides positive sealing and long service life in brake fluid environments.
- Direct replacement caps for the most popular size Wilwood brake fluid reservoirs. Order Cap P/N 330-12645 to fit the 4 ounce reservoir, or P/N 330-12646 to fit the 7, 10 and 10.7 ounce reservoirs.



Electronic Fluid Level Sensor Caps

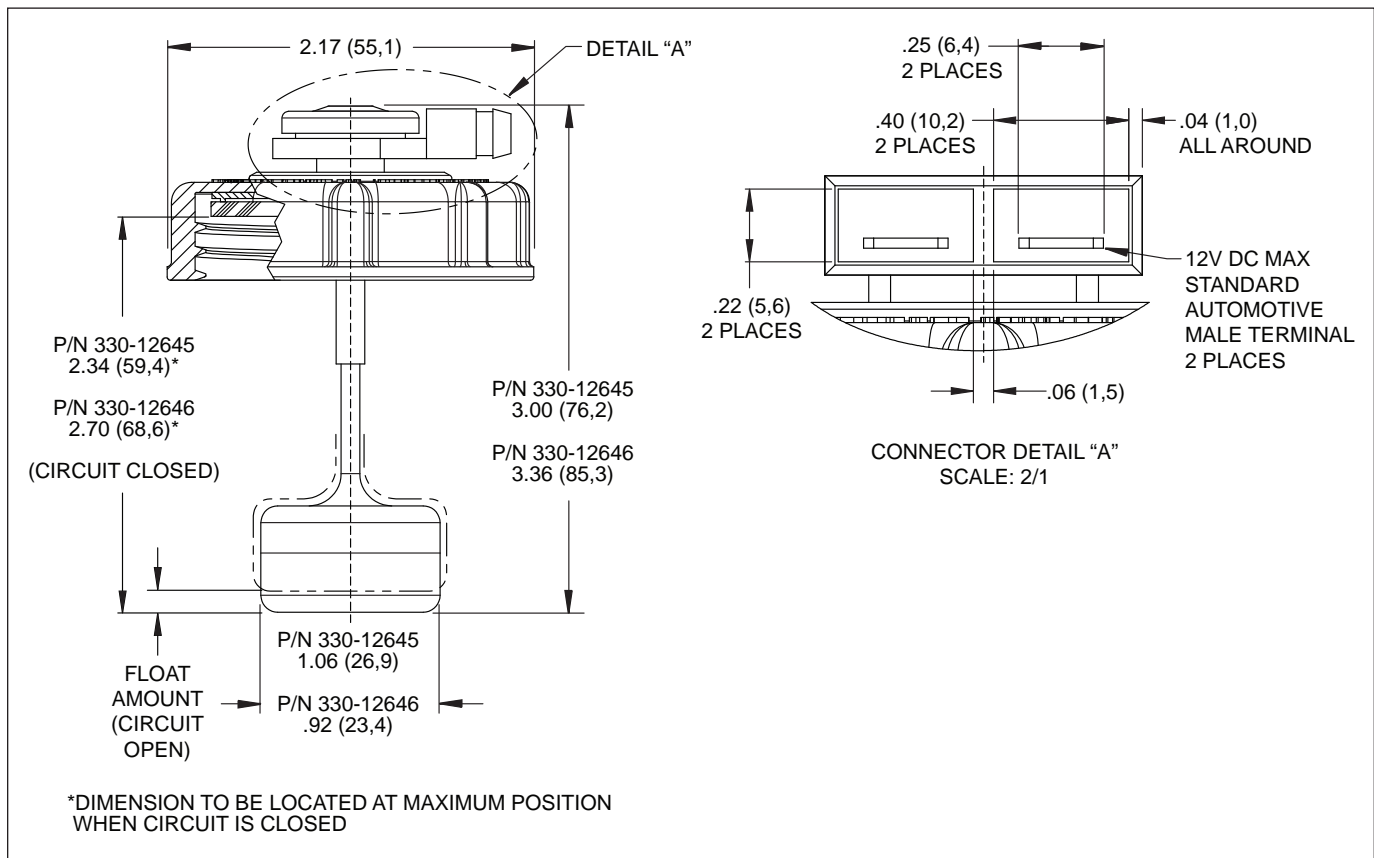

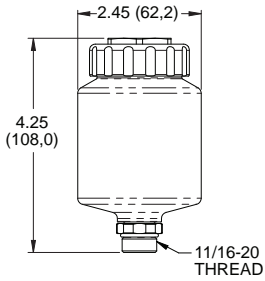

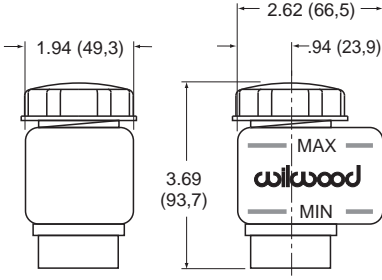

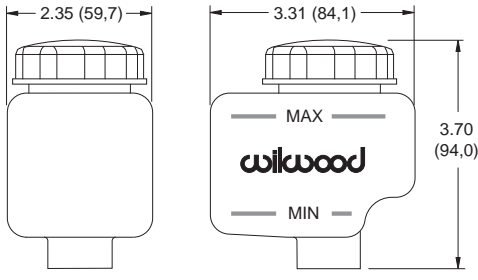

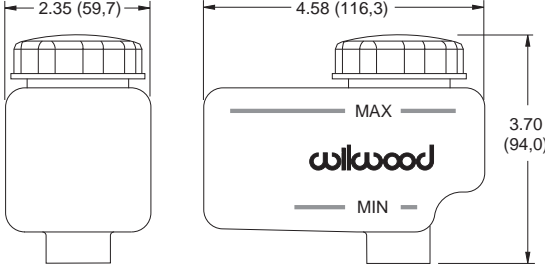

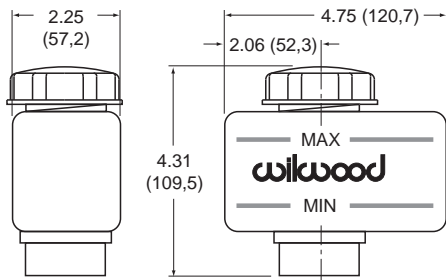

Figure 1. Reservoir Caps, Physical Characteristics

Reservoir Photo	Reservoir Dimensional Drawing	Reservoir P/N	Cap P/N
		<p>260-12696 4 Ounce Direct Mount</p> <p>260-12697 4 Ounce Remote Mount</p>	<p>330-12645</p> <p>330-12645</p>
		<p>260-5752 4 Ounce</p>	<p>330-12645</p>
		<p>260-10204 7 Ounce</p>	<p>330-12646</p>
		<p>260-10205 10 Ounce</p>	<p>330-12646</p>
		<p>260-5751 10.7 Ounce</p>	<p>330-12646</p>