

ASSEMBLY INSTRUCTIONS
FOR
STRANGE ENGINEERING FLOATER*

*For additional vehicle compatibility, visit www.wilwood.com

**SUPERLITE 4R REAR PARKING BRAKE KIT
WITH 12.88" DIAMETER VENTED ROTOR (3.49 OFFSET)**

BASE PART NUMBER

140-12435

**DISC BRAKES SHOULD ONLY BE INSTALLED BY SOMEONE
EXPERIENCED AND COMPETENT IN THE INSTALLATION AND
MAINTENANCE OF DISC BRAKES
READ ALL WARNINGS**

WARNING

IT IS THE RESPONSIBILITY OF THE PERSON INSTALLING ANY BRAKE COMPONENT OR KIT TO DETERMINE THE SUITABILITY OF THE COMPONENT OR KIT FOR THAT PARTICULAR APPLICATION. IF YOU ARE NOT SURE HOW TO SAFELY USE THIS BRAKE COMPONENT OR KIT, YOU SHOULD NOT INSTALL OR USE IT. DO NOT ASSUME ANYTHING. IMPROPERLY INSTALLED OR MAINTAINED BRAKES ARE DANGEROUS. IF YOU ARE NOT SURE, GET HELP OR RETURN THE PRODUCT. YOU MAY OBTAIN ADDITIONAL INFORMATION AND TECHNICAL SUPPORT BY CALLING WILWOOD AT (805) 388-1188, OR VISIT OUR WEB SITE AT WWW.WILWOOD.COM. USE OF WILWOOD TECHNICAL SUPPORT DOES NOT GUARANTEE PROPER INSTALLATION. **YOU**, OR THE PERSON WHO DOES THE INSTALLATION MUST KNOW HOW TO PROPERLY USE THIS PRODUCT. IT IS NOT POSSIBLE OVER THE PHONE TO UNDERSTAND OR FORESEE ALL THE ISSUES THAT MIGHT ARISE IN YOUR INSTALLATION.

RACING EQUIPMENT AND BRAKES MUST BE MAINTAINED AND SHOULD BE CHECKED REGULARLY FOR FATIGUE, DAMAGE, AND WEAR.



Need Additional Information? Use Your
SmartPhone and Jump to Our Technical
Tips Section on Our Web Site.



WARNING

**DO NOT OPERATE ANY VEHICLE ON UNTESTED BRAKES!
SEE MINIMUM TEST PROCEDURE WITHIN**

ALWAYS UTILIZE SAFETY RESTRAINT SYSTEMS AND ALL OTHER AVAILABLE SAFETY EQUIPMENT WHILE OPERATING THE VEHICLE

IMPORTANT • READ THE DISCLAIMER OF WARRANTY INCLUDED IN THE KIT

NOTE: Some cleaners may stain or remove the finish on brake system components. Test the cleaner on a hidden portion of the component before general use.

Important Notice - Read This First

Before any tear-down or disassembly begins, review the following information:

- Review the Wheel Clearance Diagram (Figure 2, page 3) to verify that there is adequate clearance with the wheels you will be using with the installation.
- Rear brake kits are not supplied with hydraulic lines or fittings and may require the purchase of additional lines or fittings to complete the installation. Wilwood offers an extensive listing of brake lines and fittings on our web site: www.wilwood.com.
- Rear brake kits are not supplied with parking brake cables hardware or adapters. Please see the note in the assembly instructions for vendor recommendations to purchase these parts.
- Due to OEM production differences and other variations from vehicle to vehicle, the fastener hardware and other components in this kit may not be suitable for a specific application or vehicle.
- It is the responsibility of the purchaser and installer of this kit to verify suitability / fitment of all components and ensure all fasteners and hardware achieve complete and proper engagement. Improper or inadequate engagement can lead to component failure.

Photographic Tip

Important and highly recommended: Take photos of brake system before disassembly and during the disassembly process. In the event, trouble-shooting photos can be life savers. Many vehicles have undocumented variations, photos will make it much simpler for Wilwood to assist you if you have a problem.

Exploded Assembly Diagram

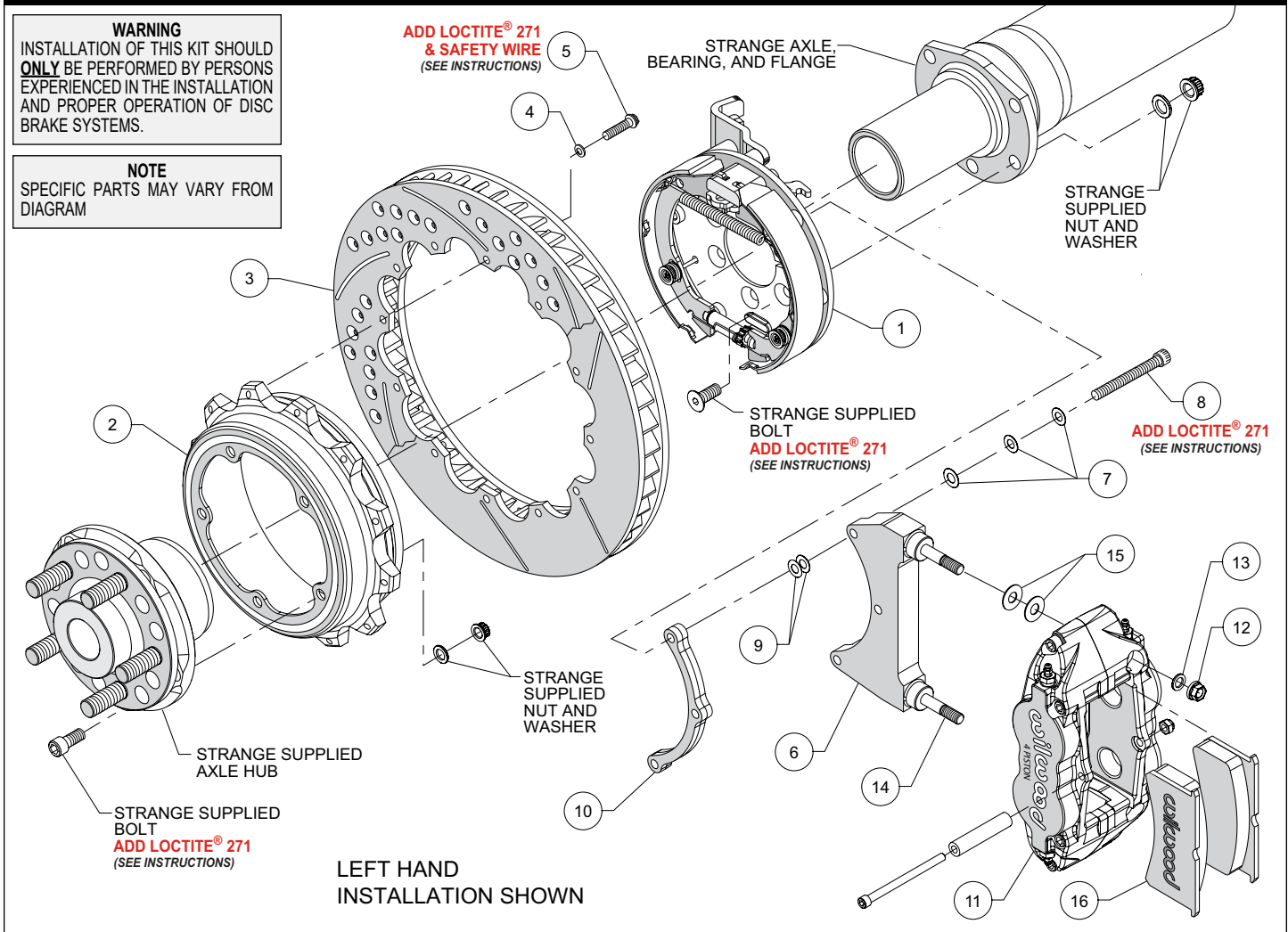

Figure 1. Typical Installation Configuration

Parts List

| ITEM NO. | PART NO. | DESCRIPTION | QTY |
|----------|-----------------|--|-----|
| 1 | 249-12448/49 | Bracket Kit (pair, one each, left and right) | 1 |
| 2 | 170-13906 | Hat, 1.66" offset, 12 x 8.75" Bolt Circle | 2 |
| 3 | 160-12961/62 | Rotor, GT 1.10" Thk x 12.88" Dia, 12 x 8.75" Bolt Circle, Right and Left | 2 |
| 3A | 160-13543/44-BK | Rotor, SRP Drilled and Slotted, Right and Left | 2 |
| 4 | 240-11240 | Washer, .265" I.D. x .500" O.D. x .063" Thick | 24 |
| 5 | 230-8037 | Bolt, 1/4-20 x .75" Long, 12 Point | 24 |
| 6 | 249-9495/96 | Bracket Caliper Mounting (pair, one each, right and left) | 2 |
| 7 | 240-10191 | Washer, .328" I.D. x .562" O.D. x .063" Thick | 18 |
| 8 | 230-13565 | Bolt, 5/16-24 x 1.75" Long, SHCS | 6 |
| 9 | 240-9609 | Shim .015" Thick | 12 |
| 10 | 300-9503 | Spacer, Caliper Bracket | 2 |
| 11 | 120-11783-BK | Caliper, Forged Narrow Superlite 4R | 2 |
| 11A | 120-11783-RD | Caliper, Forged Narrow Superlite 4R, Red | 2 |
| 12 | 230-16550 | Nut, 3/8-24 Self-Locking, 6 Point | 4 |
| 13 | 240-10190 | Washer, .391" I.D. x .625" O.D. x .063" Thick | 4 |
| 14 | 230-9078 | Stud, 3/8-16 x 3/8-24 x 2.50" Long (pre installed in bracket) | 4 |
| 15 | 240-1159 | Shim, .035" Thick | 16 |
| 16 | 150-8855K | Pad, BP-10 Compound, Axle Set | 1 |

NOTES:

P/N 230-8008 Rotor Bolt Kit, includes part numbers 230-8037 and 240-11240

P/N 249-9632-L/R Caliper Mounting Bracket Kit, includes P/N's 230-9078, 230-16550, 240-1159, 240-10190 and 249-9495/96

P/N 300-9738 Spacer Kit, includes part numbers 230-13565, 240-10191, 240-9609, and 300-9503

Item 3A is an optional item and is available in the "-D" drilled rotor kits. Add "-D" to end of part number when ordering.

Items 11A is an optional item and is available in the "-R" red caliper kits. Add "-R" to end of part number when ordering.

General Information and Disassembly Instructions

- Installation of this kit should **ONLY** be performed by persons experienced in the installation and proper operation of disc brake systems. Before assembling this Wilwood rear disc brake kit, double check the following to ensure a trouble free installation.
- Inspect the contents of this kit against the parts list to ensure that all components and hardware are included.
- Make sure this is the correct kit to fit the exact model rear end. This kit is designed to fit the Strange Engineering floating rear axle and hub, using the Strange Engineering floater axle mounting flange shown in Figure 3.
- Verify your wheel clearance using Figure 2.

Disassembly

- Disassemble the original equipment rear brakes:
 - Raise the rear wheels off the ground and support the rear suspension according to the vehicle manufacturer's instructions.
 - Remove the rear wheels and disassemble the brakes down to the bare axle.
- Remove any nicks or burrs on the axle housing flange that may interfere with the installation of the new brake components.
- Clean and de-grease the axle and housing flange.

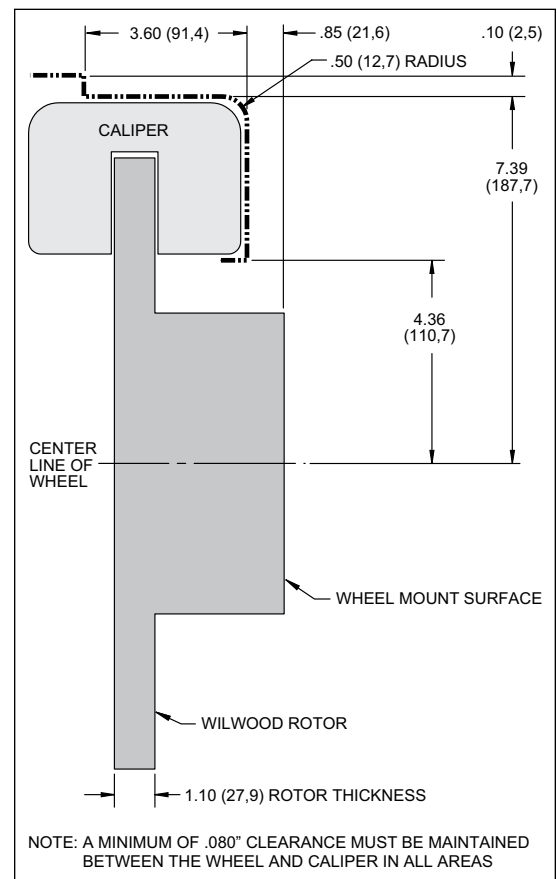

Figure 2. Wheel Clearance Diagram

Assembly Instructions

IMPORTANT:

- To ensure maximum performance from your parking brake system, the cables must be routed as straight as possible. Bends in the cable can significantly reduce efficiency and thus reduce pull force at the brake. Tight bends must be avoided with a minimum recommended bend radius of 6" to 8".
- Cables should be properly restrained to prevent "straightening" of bends when tension is applied. Restrain movement of cable by affixing the cable sheath to body or chassis by fitting cable clamps at various points over the length of cable or by using original equipment cable attachments points. The clamping method chosen will require that cable sheath be held tightly without movement, crushing or causing interference to the internal cable.
- Cables must be initially pre-stretched by multiple applications of the brake handle, then re-adjusted to correct tension.

Assembly Instructions (numbers in parenthesis refer to the parts list and Figure 1 on the preceding pages): **CAUTION:** All mounting bolts must fully engage threaded holes.

•Orient the bracket assembly (1) as shown in Figure 1 and slide it onto the axle housing flange. Ensure that the bracket assembly backing plate fits flush against the axle housing flange. Secure bracket assembly to the axle flange using bolts, washers, and lock nuts (all Strange supplied) as shown in Figure 1. Apply red *Loctite*® 271 to the bolt threads and torque to Strange specifications.

•**NOTE:** Please reference the caution statement at the beginning of the assembly instructions. The caliper mounting bracket assembly (6) should be installed first with clean, dry threads on the mounting bolts (8). Install the bracket using bolt (8), three flat washers (7), shim washer (9) and spacer (10), as shown in Figure 1. **NOTE:** End of bolt should not exceed inside face of insert. The bracket must tighten squarely against the back side of the bracket kit assembly (1). Inspect for interference from the axle flange. Use two thin shims (9) between the bracket (6) and spacer (10) during initial trial fitting. Later, after the caliper alignment has been checked, the mount bolts will be secured using red *Loctite*® 271.

•Orient the rotor (3) and the hat (2) as shown in Figure 1. Attach rotor to hat using bolts (5) and washers (4). Apply red *Loctite*® 271 to the bolt threads and torque to 155 in-lb using a criss-cross pattern.

•Orient the hat (2) and the axle hub (Strange supplied) as shown in Figure 1. Attach the hat to the axle hub using bolts, washers, and lock nuts (all Strange supplied) as shown in Figure 1. Apply red *Loctite*® 271 to the bolt threads and torque to Strange specifications.

•Slide the rotor/hat/hub assembly onto the axle as shown in Figure 1 and secure per Strange Engineering specifications.

•Initially place two .035" thick shims (15) on each stud between the caliper and the bracket, as shown in Figure 1 and Photo 1. Mount the caliper (11) onto the bracket (6) using lock nuts (12) and washers (13), Figure 1. Temporarily tighten the lock nuts and view the rotor through the top opening of the caliper. The rotor should be centered in the caliper, Photo 2. If not, adjust by adding or subtracting shims (9) between the bracket (6) and the spacer (10). Always use the same amount of shims on each of the two mounting bolts. Once the caliper alignment is correct, remove the bracket mounting bolts one at a time, apply red *Loctite*® 271 to the threads, and torque to 180 in-lb.

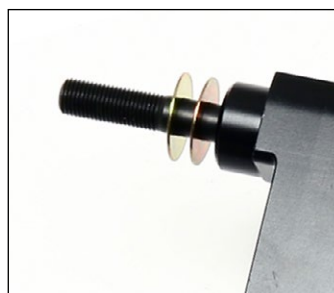

Photo 1

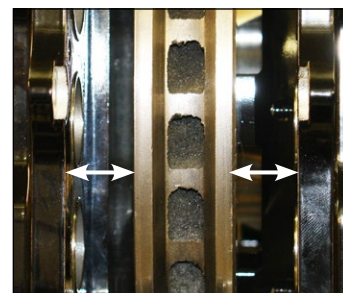

Photo 2

•Remove the caliper center bridge pad retainer bolt, nut, and tube from the caliper. Insert the brake pads (16) into the caliper, with the friction material facing the rotor, as shown in Photo 3. Check that the top of the brake pad is flush with the outside diameter of the rotor, Photo 4. If not, adjust by adding or subtracting shims (15) between the caliper and the bracket. After the caliper pad height is set, torque the caliper lock nuts (12) to 30 ft-lb. Secure the brake pads in place with the center bridge pad retainer tube, bolt, and locknut. The locknut should be snug without play in the bolt or tube. Be cautious not to over tighten.

•Temporarily install wheel and torque lug nuts to manufacturer's specification. Ensure that the wheel rotates freely without any interference.

Assembly Instructions (Continued)

•**NOTE:** Clevis and cable kits which attach to the parking brake assembly are not included in the Wilwood parking brake kit. Wilwood offers a generic style parking brake cable kit, P/N 330-9371 for this application which can be ordered separately from your local Wilwood dealer or by calling Wilwood customer service at (805) 388-1188.

•Before final installation of the wheel, remove the rubber grommet in the bracket kit assembly (1) and adjust the parking brake shoes outward (using a drum shoe adjustment tool available at your local auto parts store) while spinning the rotor/hat/hub (2/3) until a slight drag is felt against the hat/drum. Replace the rubber grommet when finished.

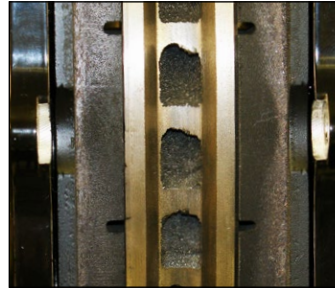

Photo 4

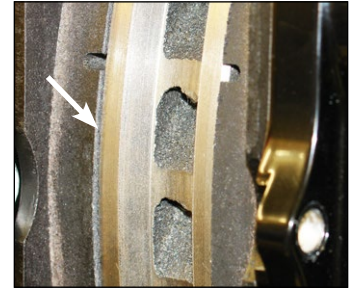

Photo 5

•**NOTE:** OEM rubber brake hoses generally cannot be adapted to Wilwood calipers. The caliper inlet fitting is a 1/8-27 NPT. The preferred method is to use steel adapter fittings at the caliper, either straight, 45 or 90 degree (use PTFE tape on pipe threads of adapter fitting for proper sealing to caliper) and enough steel braided line to allow for full suspension travel. **Carefully route hoses to prevent contact with moving suspension, brake or wheel components.** **NOTE:** Wilwood hose kits are designed for use in many different vehicle applications and it is the installer's responsibility to properly route and ensure adequate clearance and retention for brake hose components. Wilwood offers universal brake flex line hose kits, order P/N 220-7056 for the 14 inch length, P/N 220-7699 for the 16 inch length, or P/N 220-8307 for the 18 inch length. Hose kits include hoses, fitting, etc., all in one package for this application.

•**NOTE:** Specified brake hose kits may not work with all Years, Makes and Models of vehicle that this brake kit is applicable to, due to possible OEM manufacturing changes during a production vehicle's life. It is the installer's responsibility to ensure that all fittings and hoses are the correct size and length, to ensure proper sealing and that they will not be subject to crimping, strain and abrasion from vibration or interference with suspension components, brake rotor or wheel.

•In absence of specific instructions for brake line routing, the installer must use his best professional judgment on correct routing and retention of lines to ensure safe operation. Test vehicle brake system per the 'minimum test' procedure stated within this document before driving. After road testing, inspect for leaks and interference. Initially after install and testing, perform frequent checks of the vehicle brake system and lines before driving, to confirm that there is no undue wear or interference not apparent from the initial test. Afterwards, perform periodic inspections for function, leaks and wear in a interval relative to the usage of vehicle.

•Bleed the brake system, referring to the additional information and recommendations on page 6 for proper bleeding instructions. Check system for leaks after bleeding.

•Install the wheel and torque lug nuts to manufacturer's specification.

•Bed-in the brake pads per the procedure on page 8.

Assembly Instructions (Continued)

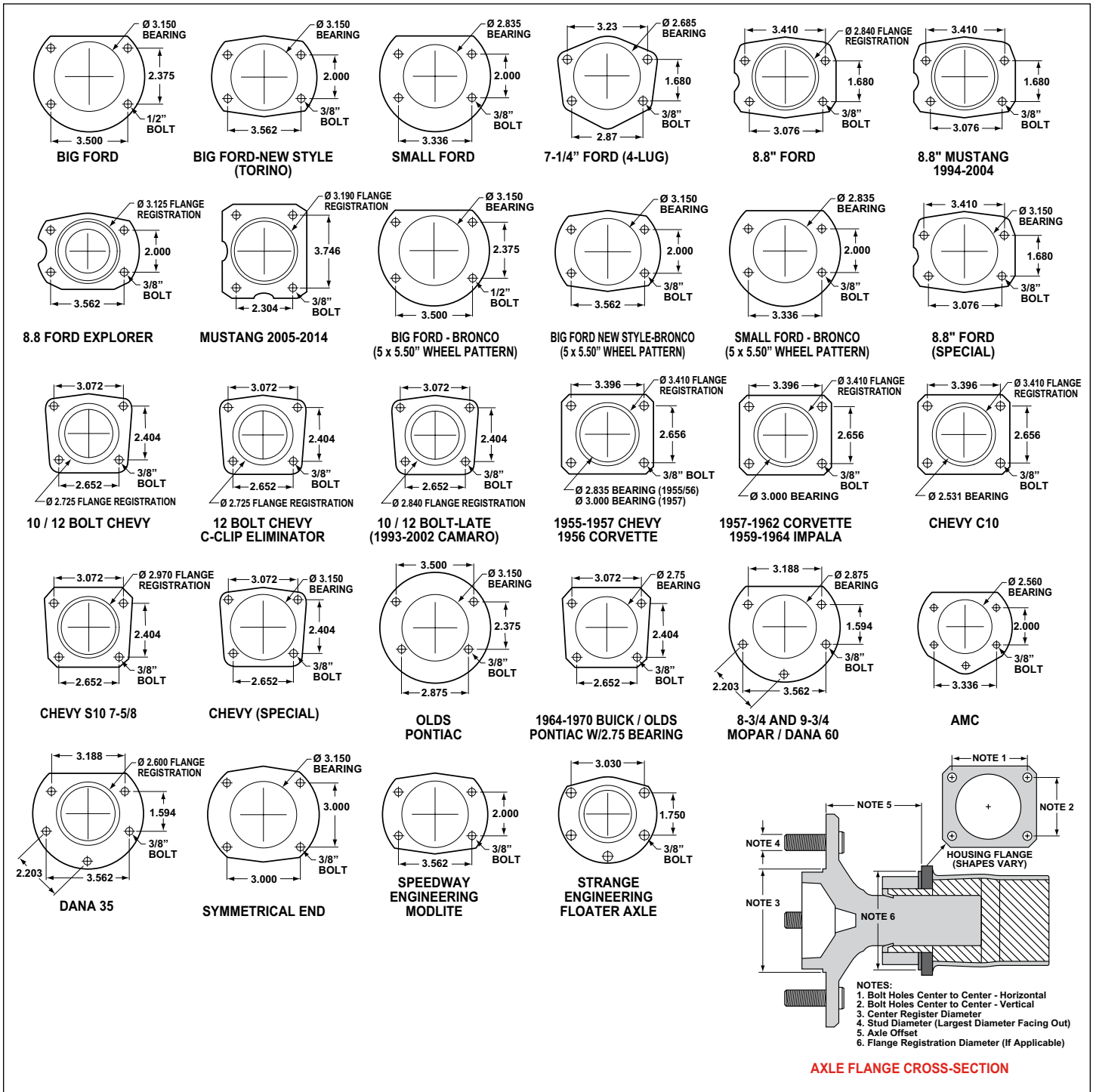

Figure 3. Rear Housing Flange Chart and Axle Flange / Offset Cross-Section

Additional Information and Recommendations

•OE Style or Single Mount Race Pedal with Tandem Outlet Master Cylinder:

Front to rear caliper piston sizes, rotor diameters, and pad compounds must be initially configured to provide the correct range of vehicle bias when using a single bore / tandem outlet master cylinder. If excessive rear brake bias is experienced, an in-line adjustable proportioning valve can be used to decrease the rear line pressure to help bring the vehicle into balance. If excessive front brake bias is experienced, first consideration should be given to increasing the rear brake bias to bring the vehicle into overall balance.

Additional Information and Recommendations (Continued)

•Race Pedal with Dual Master Cylinders and Balance Bar:

Master cylinders must be sized to match the calipers and allow the pedal balance bar to operate near the center of its travel. If it is not possible to fine tune the bias within the adjustable range of the balance bar, then consideration must be given to changing a master cylinder bore size or some other aspect of the brake system to bring the car into balance. Larger bore master cylinders will generate less pressure while decreasing pedal travel. Smaller bores master cylinders will generate higher line pressures with an increase in pedal travel.

•Fill and bleed the new system with Wilwood Hi-Temp° 570 grade fluid or higher. For severe braking or sustained high heat operation, use Wilwood EXP 600 Plus Racing Brake Fluid. Used fluid must be completely flushed from the system to prevent contamination. **NOTE:** *Silicone DOT 5 brake fluid is **NOT** recommended for racing or performance driving.*

•To properly bleed the brake system, begin with the caliper farthest from the master cylinder. Bleed the outboard bleed screw first, then the inboard. Repeat the procedure until all calipers in the system are bled, ending with the caliper closest to the master cylinder. **NOTE:** *When using a new master cylinder, it is important to bench bleed the master cylinder first.*

•If the master cylinder is mounted lower than the disc brake calipers, some fluid flow back to the master cylinder reservoir may occur, creating a vacuum effect that retracts the caliper pistons into the housing. This will cause the pedal to go to the floor on the first stroke until it has “pumped up” and moved all the pistons out against the pad again. A Wilwood in-line two pound residual pressure valve, installed near the master cylinder will stop the fluid flow back and keep the pedal firm and responsive.

•Test the brake pedal. It should be firm, not spongy and stop at least 1 inch from the floor under heavy load.

If the brake pedal is spongy, bleed the system again.

If the brake pedal is initially firm, but then sinks to the floor, check the system for fluid leaks. Correct the leaks (if applicable) and then bleed the system again.

If the brake pedal goes to the floor and continued bleeding of the system does not correct the problem, a master cylinder with increased capacity (larger bore diameter) will be required. Wilwood offers various lightweight master cylinders with large fluid displacement capacities.

•**NOTE:** *With the installation of after market disc brakes, the wheel track may change depending on the application. Check your wheel offset before final assembly.*

•If after following the instructions, you still have difficulty in assembling or bleeding your Wilwood disc brakes, consult your local chassis builder, or retailer where the kit was purchased for further assistance.

Brake Testing

WARNING • DO NOT DRIVE ON UNTESTED BRAKES BRAKES MUST BE TESTED AFTER INSTALLATION OR MAINTENANCE MINIMUM TEST PROCEDURE

- Make sure pedal is firm: Hold firm pressure on pedal for several minutes, it should remain in position without sinking. If pedal sinks toward floor, check system for fluid leaks. **DO NOT** drive vehicle if pedal does not stay firm or can be pushed to the floor with normal pressure.
- At very low speed (2-5 mph) apply brakes hard several times while turning steering from full left to full right, repeat several times. Remove the wheels and check that components are not touching, rubbing, or leaking.
- Carefully examine all brake components, brake lines, and fittings for leaks and interference.
- Make sure there is no interference with wheels or suspension components.
- Drive vehicle at low speed (15-20 mph) making moderate and hard stops. Brakes should feel normal and positive. Again check for leaks and interference.
- Always test vehicle in a safe place where there is no danger to (or from) other people or vehicles.
- Always wear seat belts and make use of all safety equipment.

Pad and Rotor Bedding

BEDDING STEPS FOR NEW PADS AND ROTORS – ALL COMPOUNDS

Once the brake system has been tested and determined safe to operate the vehicle, follow these steps for the bedding of all new pad materials and rotors. These procedures should only be performed on a race track, or other safe location where you can safely and legally obtain speeds up to 65 MPH, while also being able to rapidly decelerate.

- Begin with a series of light decelerations to gradually build some heat in the brakes. Use an on-and-off the pedal technique by applying the brakes for 3-5 seconds, and then allow them to fully release for a period roughly twice as long as the deceleration cycle. If you use a 5 count during the deceleration interval, use a 10 count during the release to allow the heat to sink into the pads and rotors.
- After several cycles of light stops to begin warming the brakes, proceed with a series of medium to firm deceleration stops to continue raising the temperature level in the brakes.
- Finish the bedding cycle with a series of 8-10 hard decelerations from 55-65 MPH down to 25 MPH while allowing a proportionate release and heat-sinking interval between each stop. The pads should now be providing positive and consistent response.
- If any amount of brake fade is observed during the bed-in cycle, immediately begin the cool down cycle.
- Drive at a moderate cruising speed, with the least amount of brake contact possible, until most of the heat has dissipated from the brakes. Avoid sitting stopped with the brake pedal depressed to hold the car in place during this time. Park the vehicle and allow the brakes to cool to ambient air temperature.

COMPETITION VEHICLES

- If your race car is equipped with brake cooling ducts, blocking them will allow the pads and rotors to warm up quicker and speed up the bedding process.
- Temperature indicating paint on the rotor and pad edges can provide valuable data regarding observed temperatures during the bedding process and subsequent on-track sessions. This information can be highly beneficial when evaluating pad compounds and cooling efficiencies.

POST-BEDDING INSPECTION – ALL VEHICLES

- After the bedding cycle, the rotors should exhibit a uniformly burnished finish across the entire contact face. Any surface irregularities that appear as smearing or splotching on the rotor faces can be an indication that the brakes were brought up to temperature too quickly during the bedding cycle. If the smear doesn't blend away after the next run-in cycle, or if chatter under braking results, sanding or resurfacing the rotors will be required to restore a uniform surface for pad contact.

PRE-RACE WARM UP

- Always make every effort to get heat into the brakes prior to each event. Use an on-and-off the pedal practice to warm the brakes during the trip to the staging zone, during parade laps before the flag drops, and every other opportunity in an effort to build heat in the pads and rotors. This will help to ensure best consistency, performance, and durability from your brakes.

DYNO BEDDED COMPETITION PADS AND ROTORS

- Getting track time for a proper pad and rotor bedding session can be difficult. Wilwood offers factory dyno-bedded pads and rotors on many of our popular competition pads and **Spec 37** GT series rotors. Dyno-bedded parts are ready to race on their first warm up cycle. This can save valuable time and effort when on-track time is either too valuable or not available at all, Dyno-bedding assures that your pads and rotors have been properly run-in and are ready to go. Contact your dealer or the factory for more information on Wilwood Dyno-Bedding services.

NOTE: NEVER allow the contact surfaces of the pads or rotors to be contaminated with brake fluid. Always use a catch bottle with a hose to prevent fluid spill during all brake bleeding procedures.

Parking Brake

WARNING • PARKING BRAKE

- Parking brake must be properly adjusted before use and must be manually readjusted for wear if parking brake handle or foot lever travel becomes excessive.
- The holding ability of the brake should be tested by stopping on a sloping surface and applying the parking brake while holding car with the hydraulic foot brake. This should be accomplished both facing up and down hill.
- Do not rely exclusively on the parking brake to hold the car; Curb wheels as recommended by the applicable diagram and put gear selector in park, or shift into first gear or reverse with a manual transmission.

- Diagram A - When parking facing downhill, turn front wheels towards the curb or right shoulder. This will keep from rolling into traffic if the brakes become disengaged.
- Diagram B - Turn the steering wheel to the left so the wheels are turned towards the road if you are facing uphill with a curb. The tires will catch the curb if the car rolls backward.
- Diagram C - When facing uphill without a curb, turn the wheels sharply to the right. If the vehicle rolls, it will go off the road rather than into traffic.
- When parking on a hill, always set the parking brake and move the gear selector into park, or shift into first or reverse gear if your vehicle has a manual transmission.

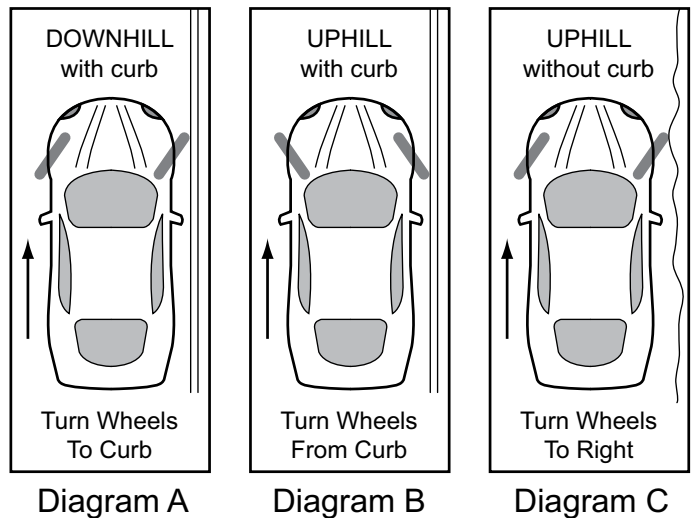

Connect with Wilwood

Wilwood Facebook



Wilwood Instagram



Wilwood Twitter



Wilwood YouTube



Associated Components

| <u>PART NO.</u> | <u>DESCRIPTION</u> |
|---------------------------|---|
| 260-13706 | Wilwood Residual Pressure Valve (2 lb for disc brakes) |
| 260-13707 | Wilwood Residual Pressure Valve (10 lb for drum brakes) |
| 260-8419 | Wilwood Proportioning Valve, Knob Style |
| 260-8420 | Wilwood Proportioning Valve, Lever Style |
| 260-11179 | Wilwood Combination Proportioning Valve with Brake Light Switch |
| 290-0632 | Wilwood Racing Brake Fluid (Hi-Temp° 570) (12 oz) |
| 290-6209 | Wilwood Racing Brake Fluid (EXP 600 Plus) (16.9 oz) |
| 340-13831 | Wilwood Floor Mount Brake Pedal (with balance bar) |
| 340-13832 | Wilwood Swing Mount Brake Pedal (with balance bar) |
| 260-6764 | Wilwood 3/4 inch High Volume Aluminum Master Cylinder |
| 260-6765 | Wilwood 7/8 inch High Volume Aluminum Master Cylinder |
| 260-6766 | Wilwood 1 inch High Volume Aluminum Master Cylinder |
| 260-4893 | 1-1/16 inch Tandem Master Cylinder (aluminum housing) |
| 260-8555 | Wilwood 1 inch Aluminum Tandem Chamber Master Cylinder |
| 260-8556 | Wilwood 1-1/8 inch Aluminum Tandem Chamber Master Cylinder |
| 220-0506 | Stainless Steel Braided Flexline Kit, Universal, 14 Inch, Domestic, 3/8-24 IF |
| 220-7699 | Stainless Steel Braided Flexline Kit, Universal, 16 Inch, Domestic, 3/8-24 IF |
| 220-8307 | Stainless Steel Braided Flexline Kit, Universal, 18 Inch, Domestic, 3/8-24 IF |